

track.12
 proyector led
 ficha técnica
 datasheet

ref. 5550826

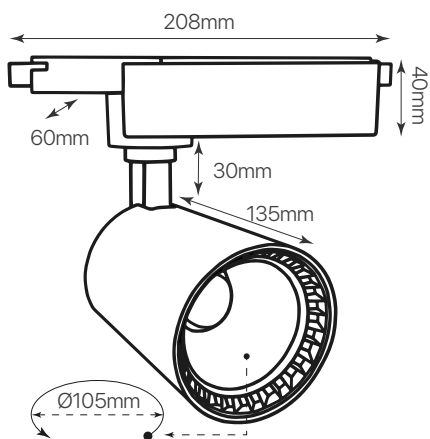

Nombre / Name	Track. 12
Referencia / Reference	5550826
Materiales / Materials	Aluminio + PC / Aluminum + PC
Difusor / Diffuser	Cristal / Glass
Potencia / Power	30W
Temperatura de color / Color temperature	3000K
Flujo luminoso / Luminous flux	3000 lm
Dimable / Dimmable	-
Ángulo de apertura / Beam angle	24°
Ángulo de inclinación / Inclination angle	90° / 360°
IP	IP20
IK	-
F.P	>0.5
UGR	-
IRC	>83
Chip	COB EPISTAR
Driver	i-TEC SERIES
Vida media (duración) / Average life	>30.000 h
Clase energética / Energy class	A+
Aislamiento eléctrico / Electrical isolation	Clase I / Class I
Colores / Colors	Blanco / White
Medida exterior / Product size	208mm x 60mm x 40mm x 135mm x Ø105mm
Medidas de corte / Cutting measurements	-
Tª (ambiente/trabajo) / Tª (environment/work)	-20°C ~ +50°C
Input	AC 100 ~ 240V
Output	DC 27~42V 720mA ±5%
Frecuencia / Frequency	50 / 60Hz
Peso / Weight	0,65 Kg
Certificados / Certificates	CE RoHS
Garantía / Warranty	2 años / 2 years